

IMPIANTO FILTRANTE MODULARE

(SOLUZIONE A 2 ELEMENTI MOD. KR - 4C)

ACCIAIO INOX AISI 304

MODELLI STANDARD

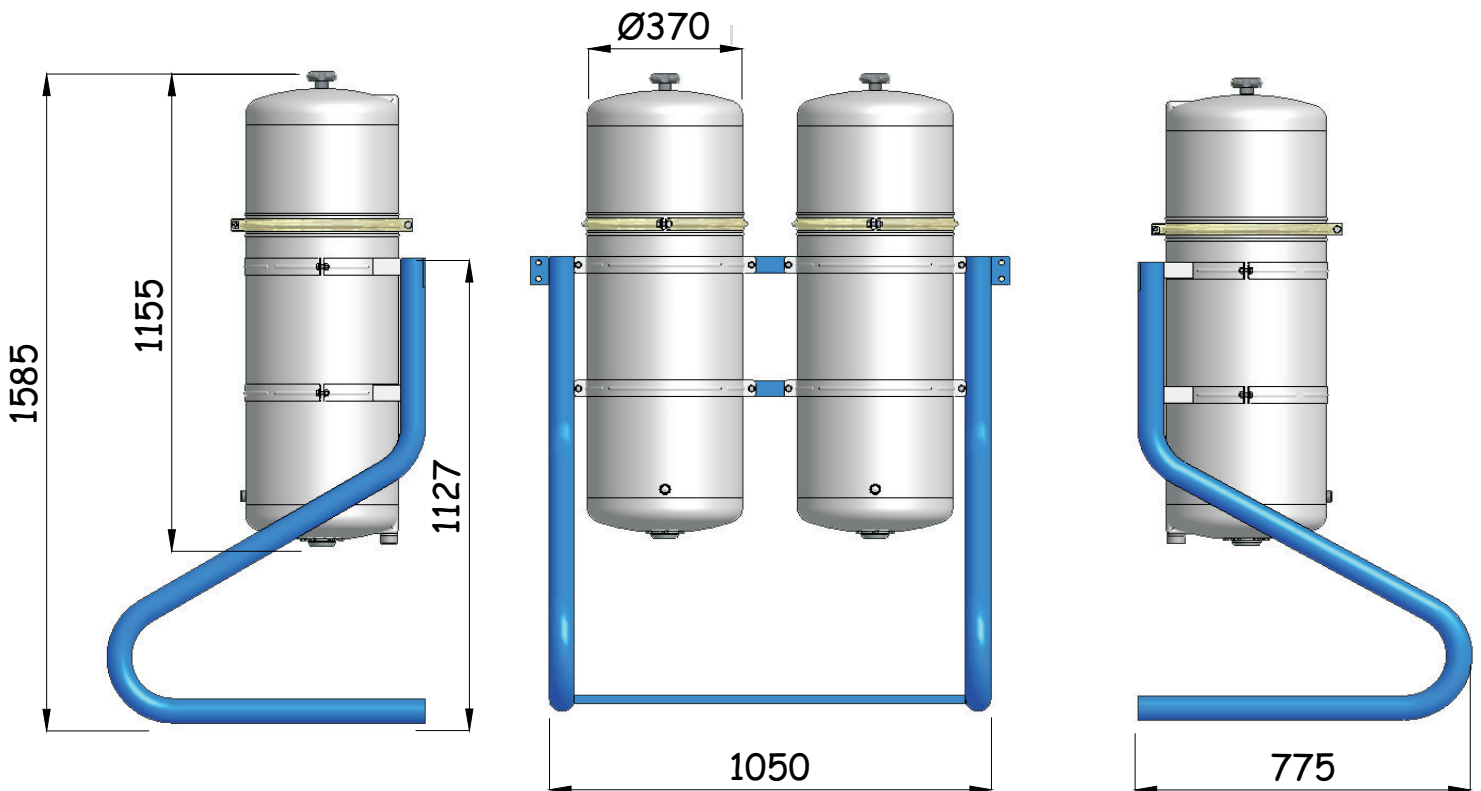
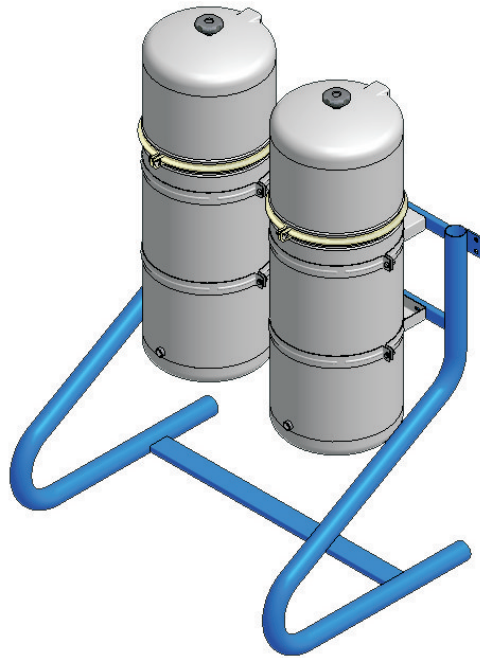

CODICE	MODELLO
8.0905.0	IMPIANTO FILTRANTE A 2 ELEMENTI MOD. KR - 4C